

DORSI 1D

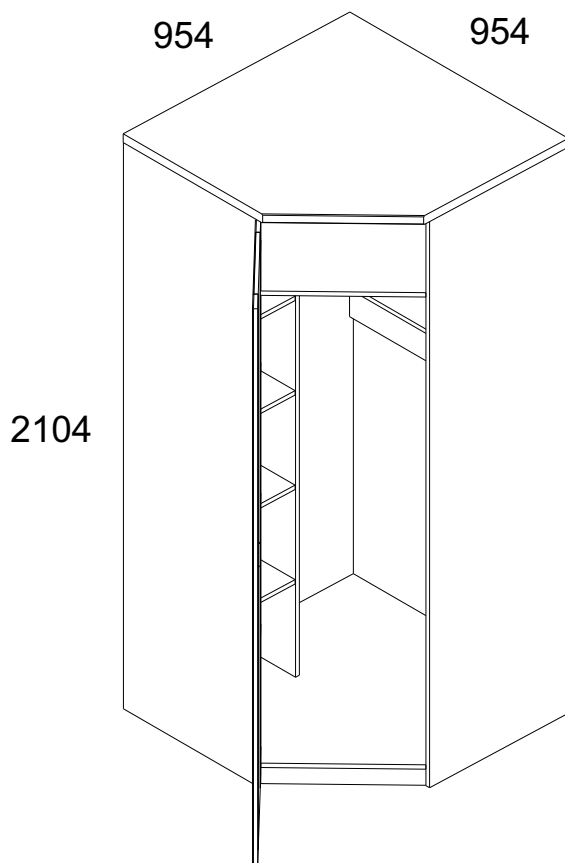

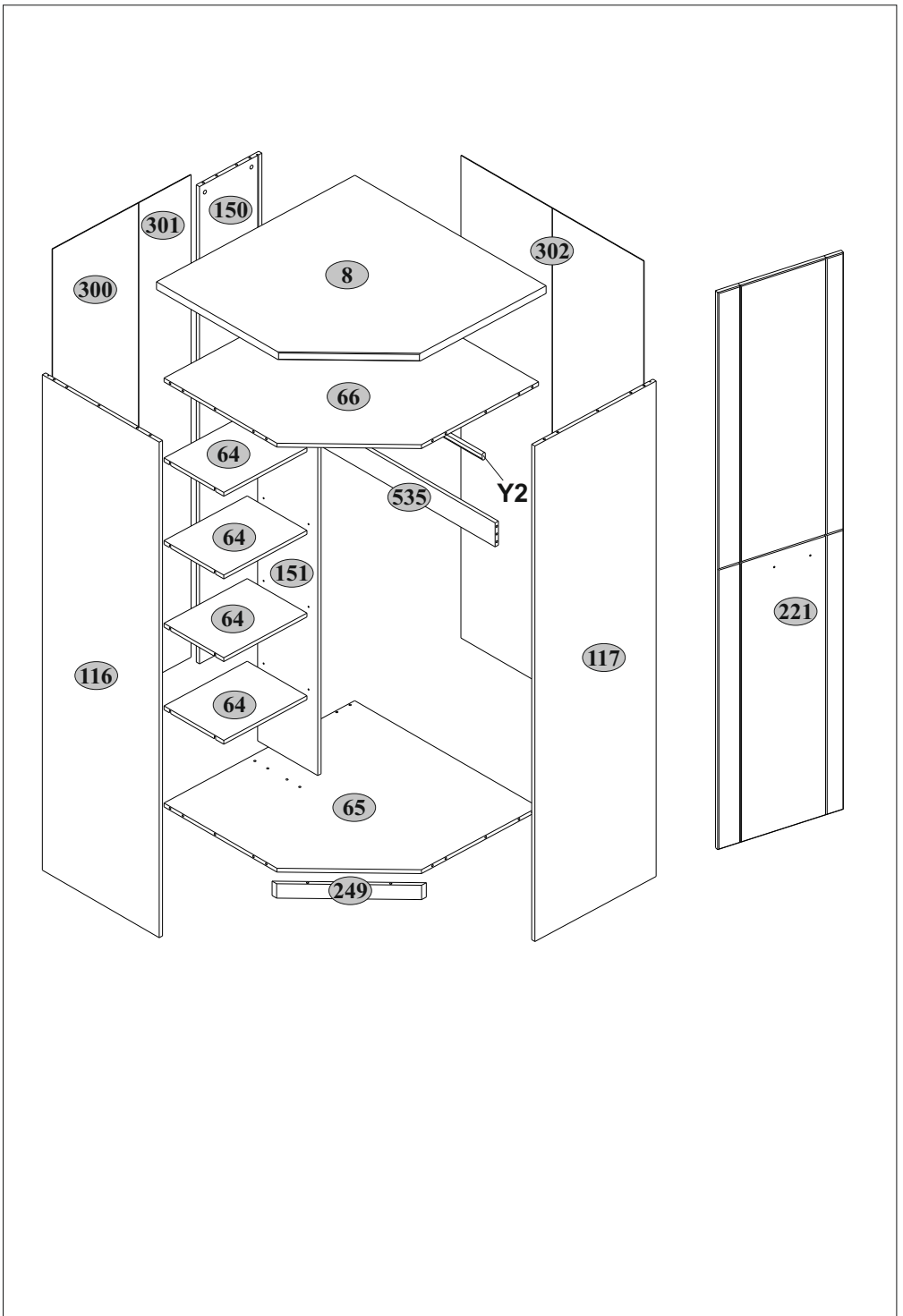

№	L, mm	B, mm	H, mm	Q	№ pack
8	954	954	32	1	1/3
64	400	298	16	4	1/3
65	917	917	16	1	1/3
66	917	917	16	1	1/3
116	2068	583	16	1	2/3
117	2068	583	16	1	2/3
150	1992	300	16	1	3/3
151	1708	300	16	1	3/3
249	534	60	16	1	3/3
221	2031	496	16	1	3/3
300	2014	414	2,5	1	2/3
301	2014	252	2,5	1	2/3
302	2014	456	2,5	2	2/3
535	901	100	16	1	3/3
Y2	894			1	1/3

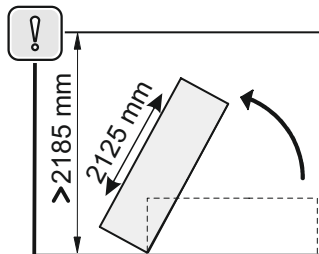
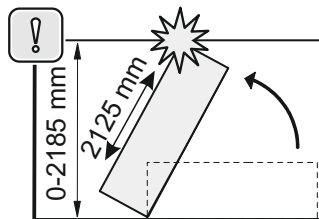

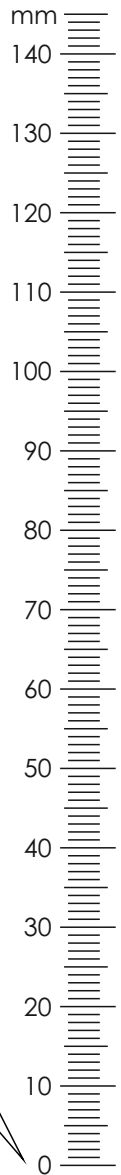

A1 7x34 28	A2 Ø15x12 28	A7 16	A8 20x13 16
B5 10x50 1	C1 8x35 22	D1-2 5	E5-1 45° 5
H58 1	I S4 1	N1 4	N20 1
R3 3x20 20	R23 6,3x13 10	R24 7x50 4	R32 4x27 2
R102 3,5x16 31	S1 24	S3 6	S5 Ø18 16
U 130x35x15 1	Y1 2		

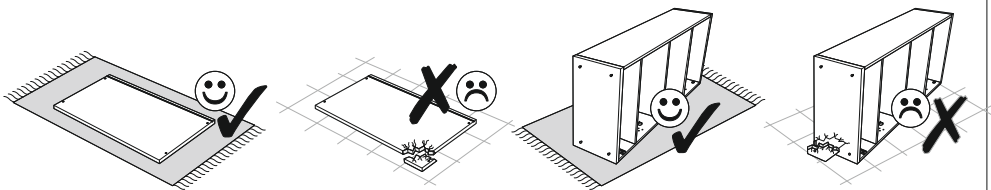
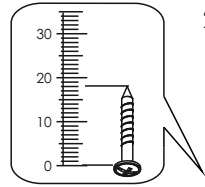
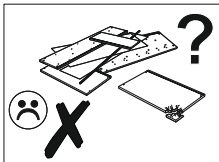
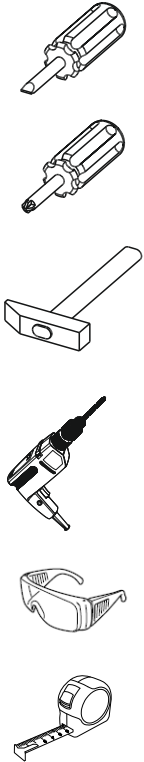

1

A1



7x34

C1

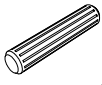

8x35

D1-2

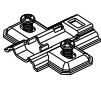

5

N1



R23



6,3x13

10

R102



3,5x16

Y1



4

2

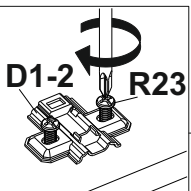
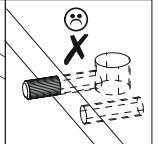
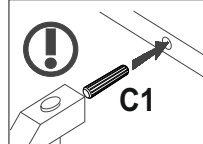

D1-2

R23

116

117

151

150

R102

Y1

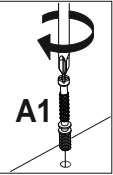

A1

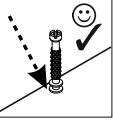

2

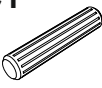
A1  7x34 12	C1  8x35 10
---	---

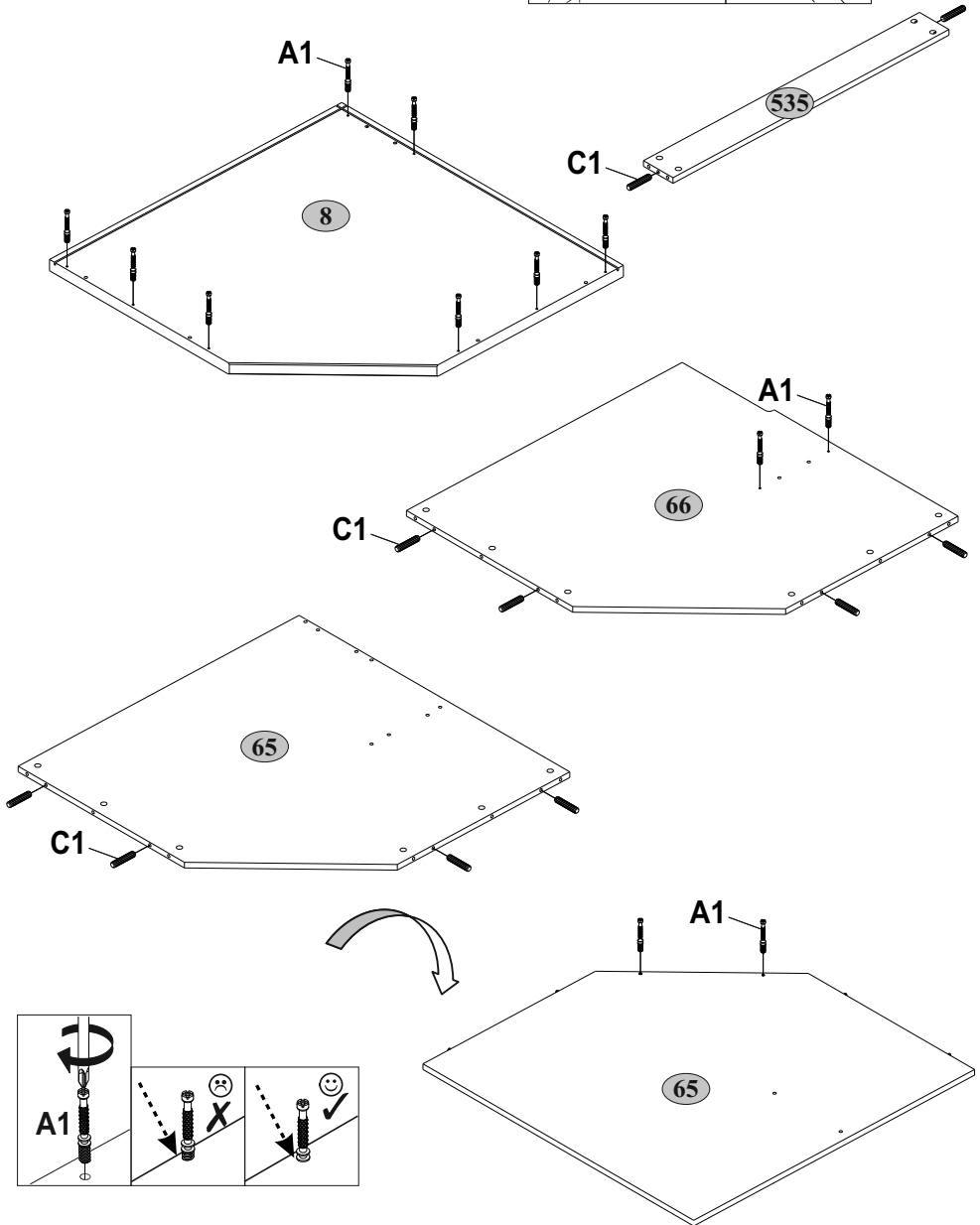
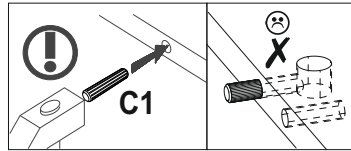

3

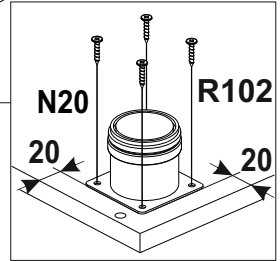
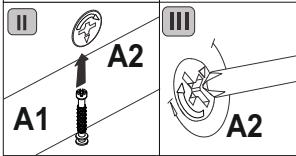
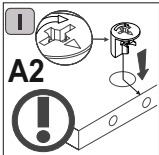
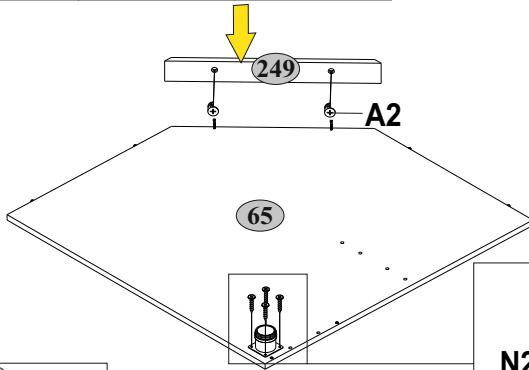
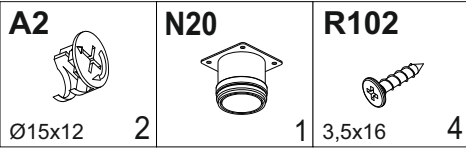

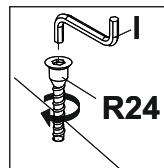
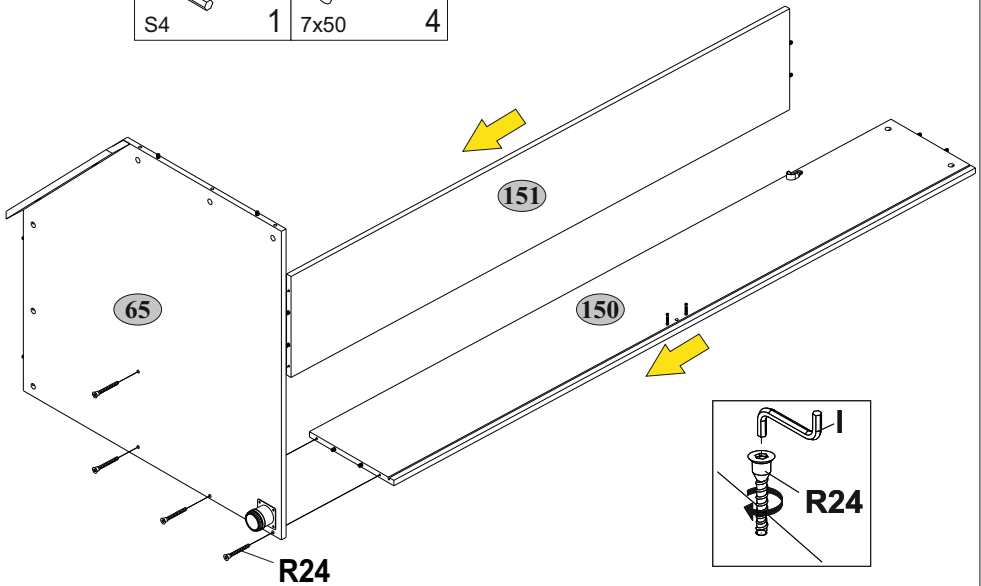
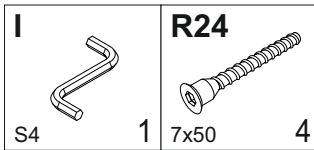

4

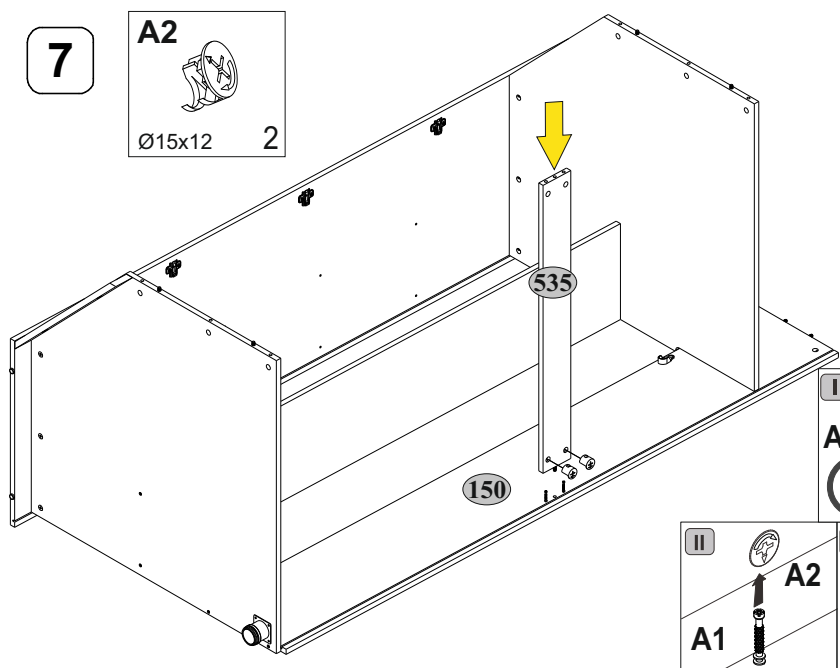

7

A2

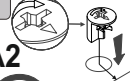
 Ø15x12 2

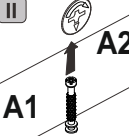

I

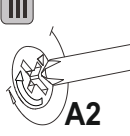
A2

II

A1 **A2**

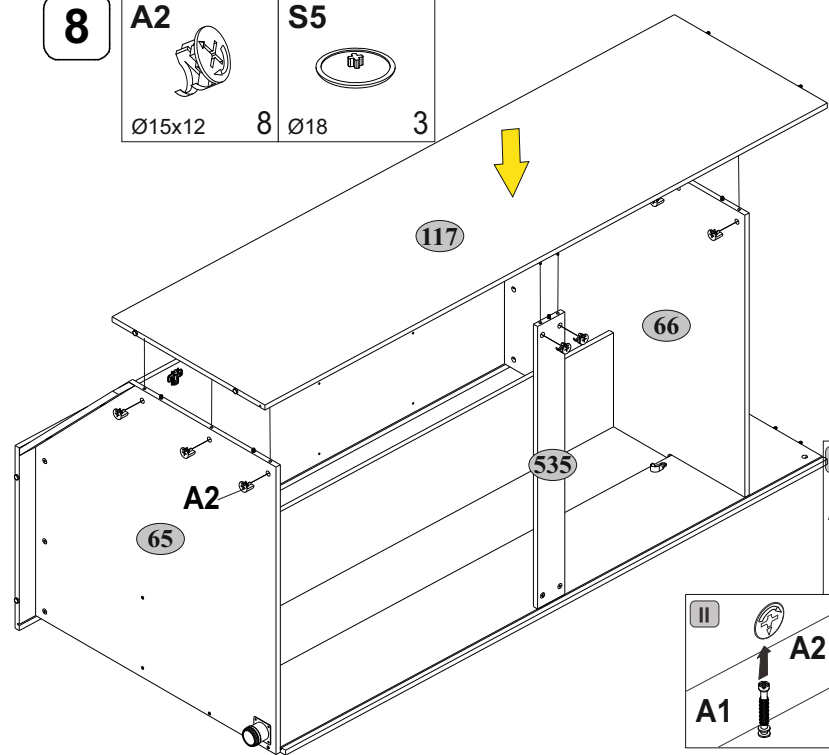

III

A2

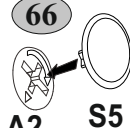
8

A2 **S5**

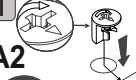
 Ø15x12 8 Ø18 3

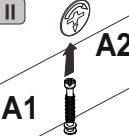

66

A2 **S5**

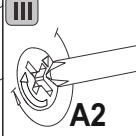
I

A2

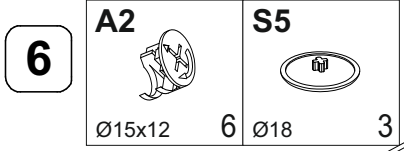
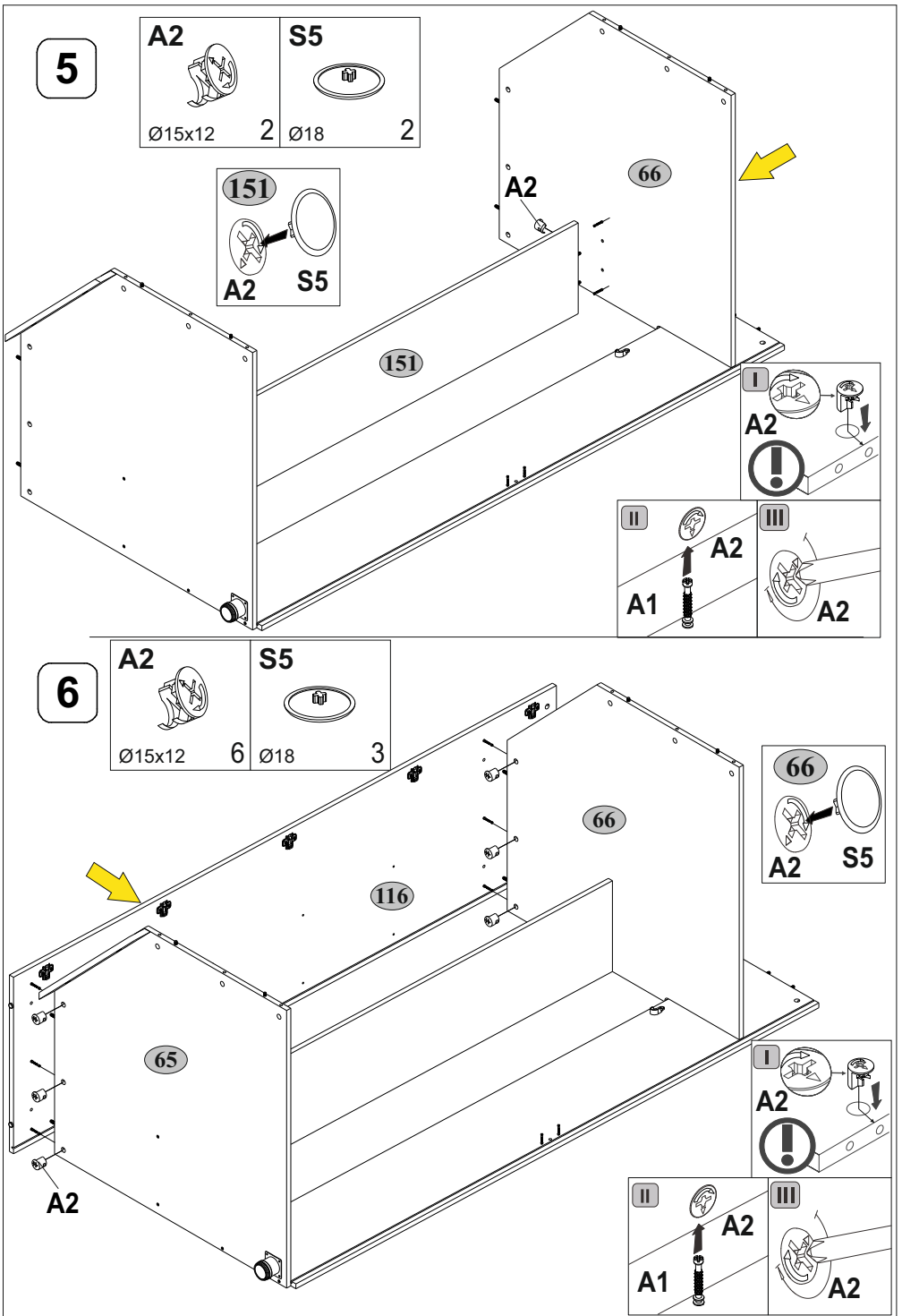
II

A1 **A2**

III

A2



11

R3



3x20

R102



8

3,5x16

S1

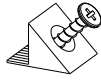

4

16

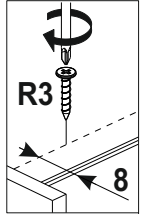
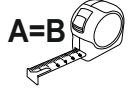
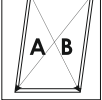
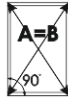

R102

302

310

R3

8

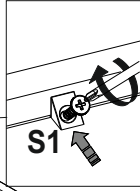

S1

R3

A

B

150

1072

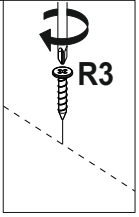

R3

12

150

301

300

116

8

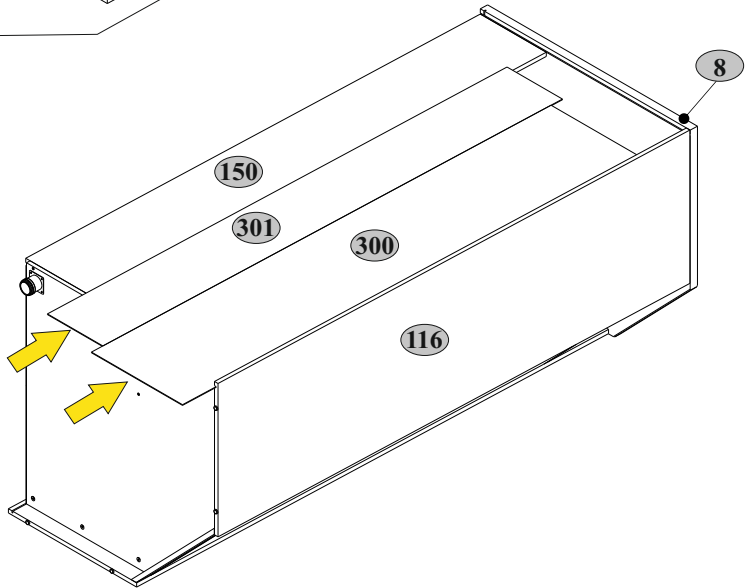

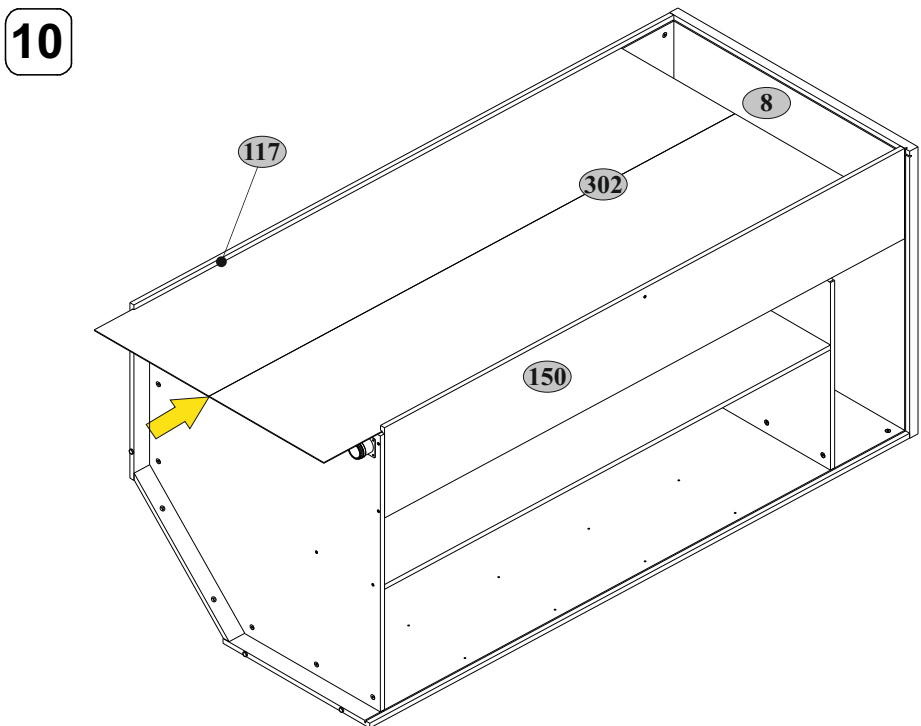
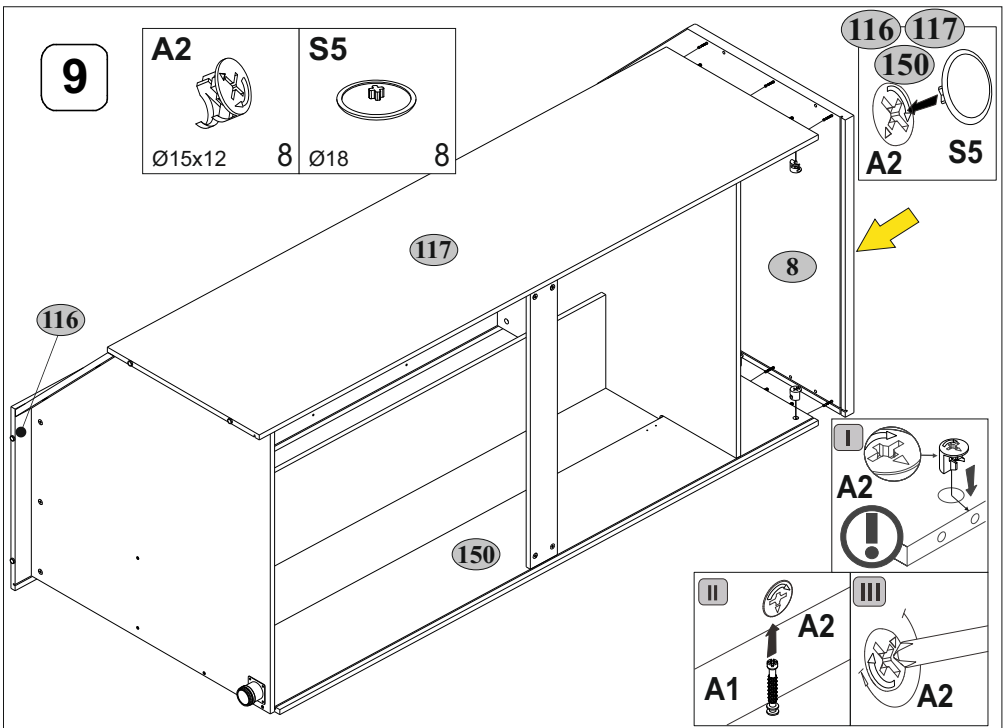

13

R3



3x20

R102



3,5x16

S1



8

S3

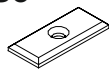

6

S1

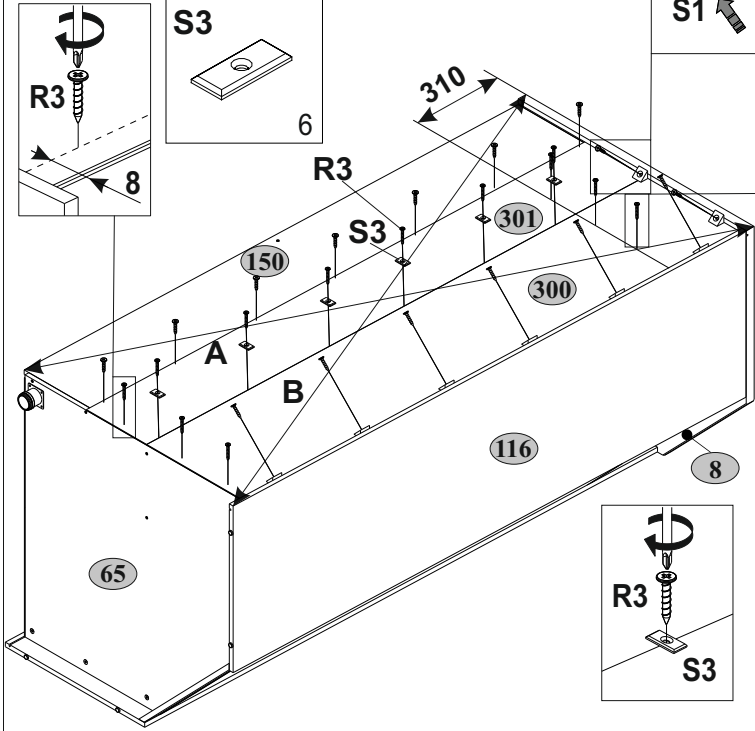
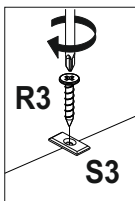
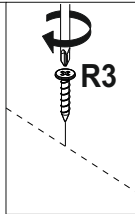
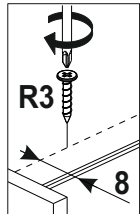
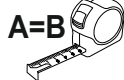
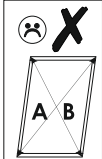
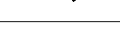

14

E5-1

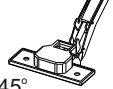

45°

5

H58

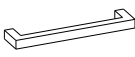

1

R32



4x27

2

R102



3,5x16

10

R102

E5-1



R32

221

H58

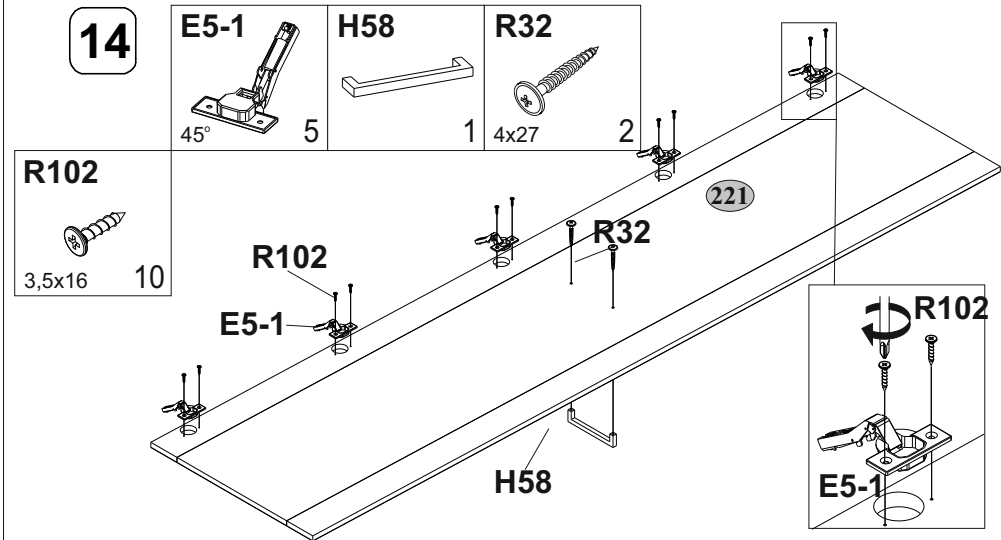
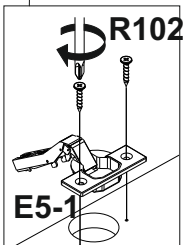
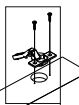

15

x4

A8



20x13

16

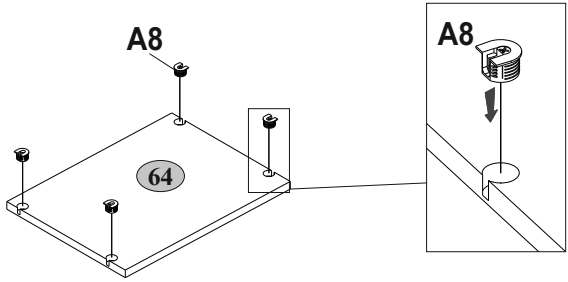

16

A7



16

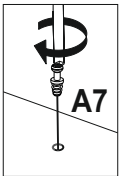

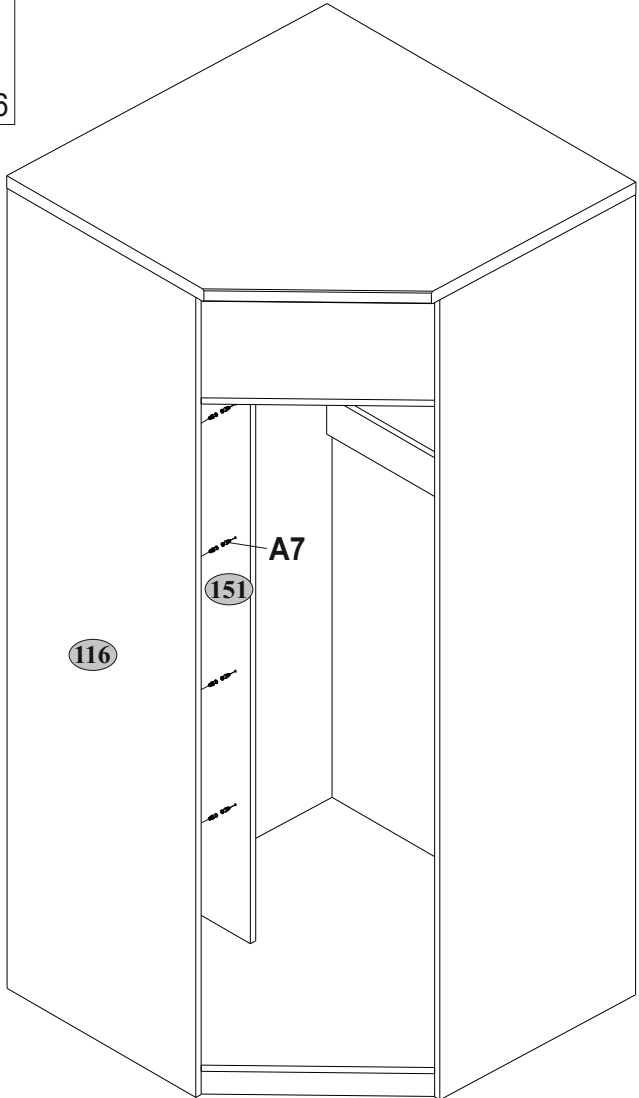
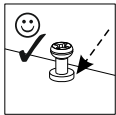
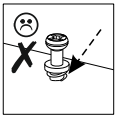

A7



17

B5

10x50 1

R102

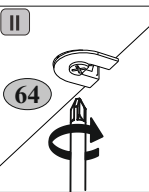
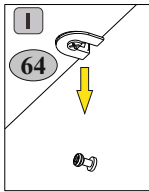
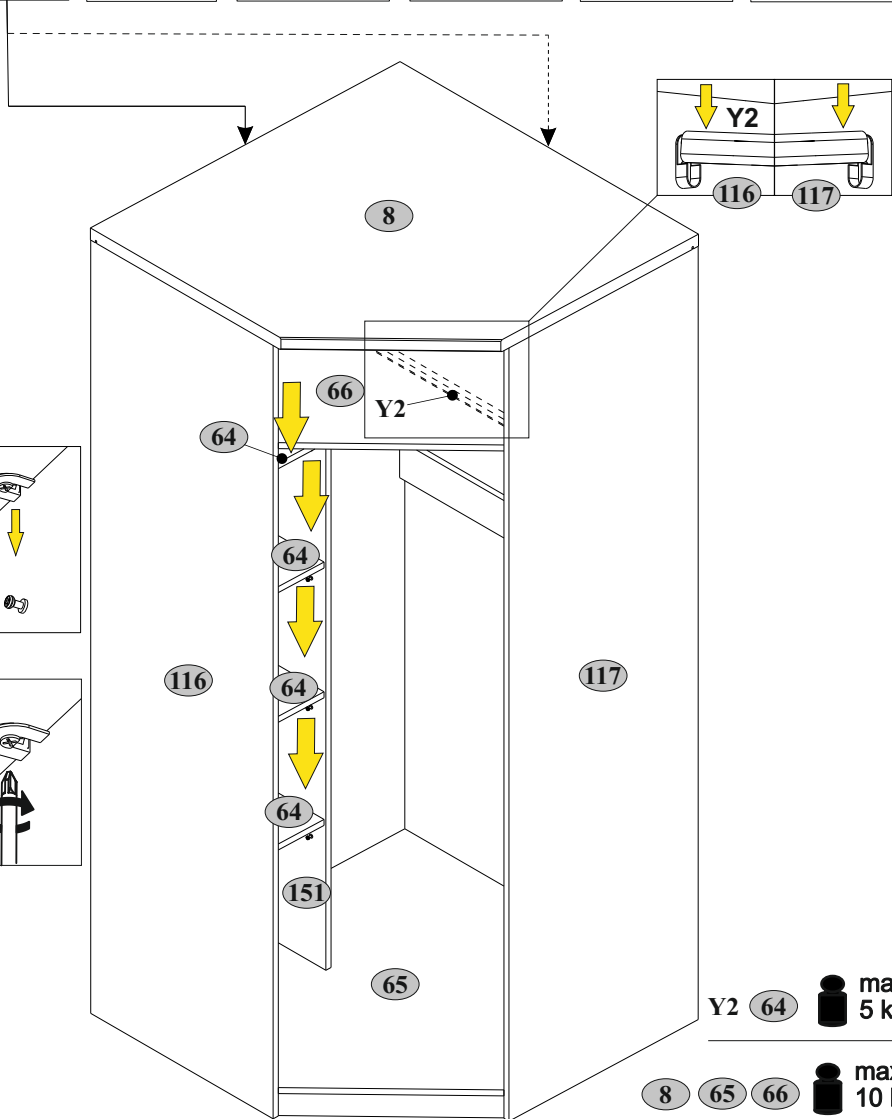
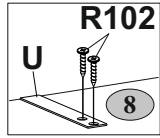
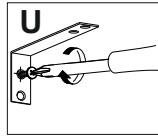
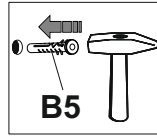
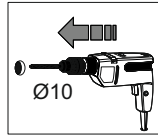
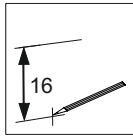
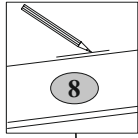
3,5x16 2

U

130x35x15 1



Y2  max. 5 kg

   max. 10 kg

18

